

Article number: 20240843930DD

Description: E+G Telescope-Liאר motion bearings GN 2408-43-930-DD

Measures

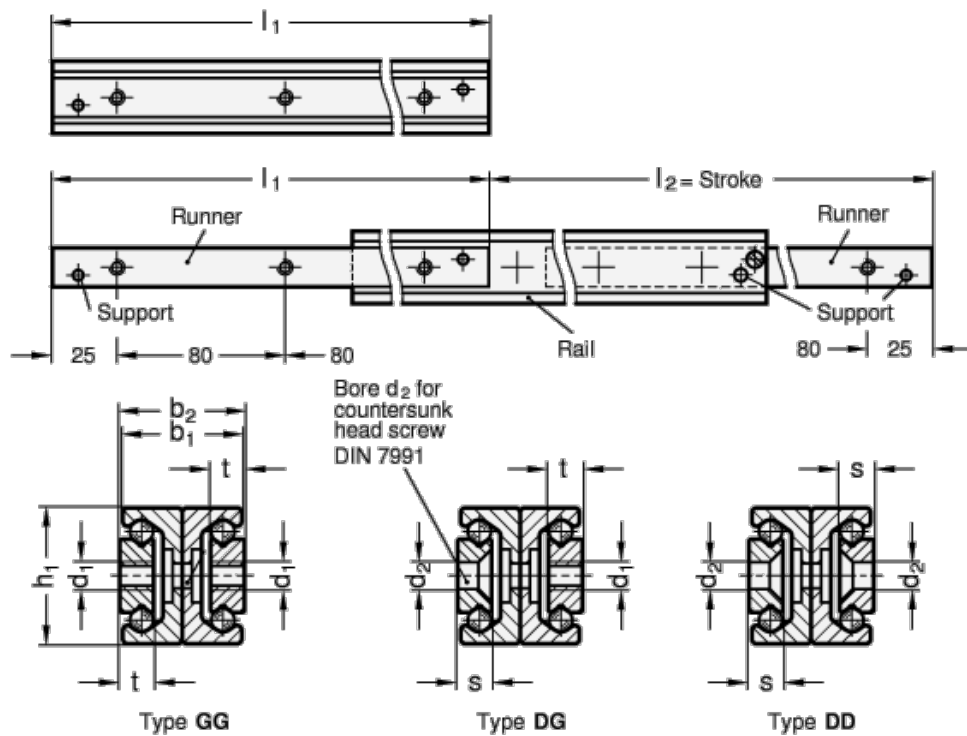

$b_1 = 42$
 $b_2 = 44$
 $d_1 =$
 $d_2 = 8.5$
 $h_1 = 43$
 $L_1 = 930 - 966$
 $s = 4.5$
 $t =$

Weight in (g) = 9770